

RoHS Compliant

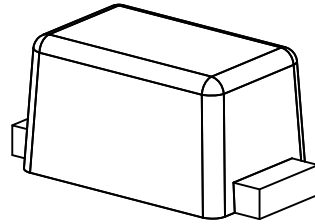
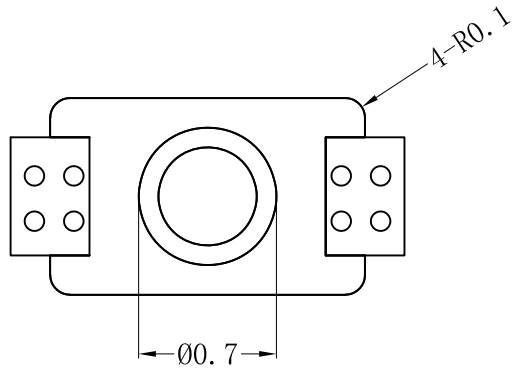

ORDER INFORMATION:

**MD-201009-H1MA-R**

PART No. \_\_\_\_\_  
 No. OF CIRCUITS: \_\_\_\_\_  
 Length \_\_\_\_\_  
 Width \_\_\_\_\_  
 Height \_\_\_\_\_

PACKAGING: R=REEL  
 PLATING: A=Tin-plated  
 PLASTIC MATERIAL: H1M=PA9T (Nature)

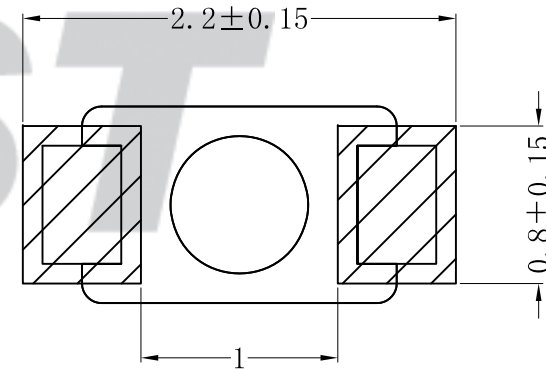
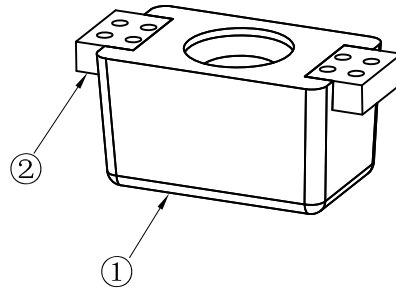
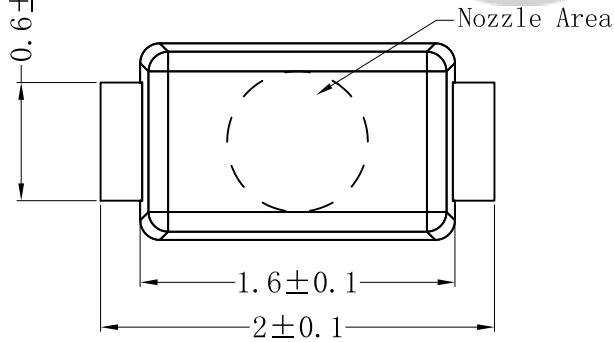
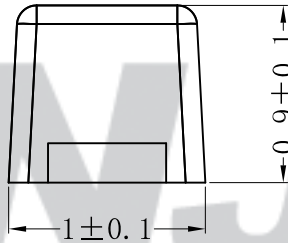
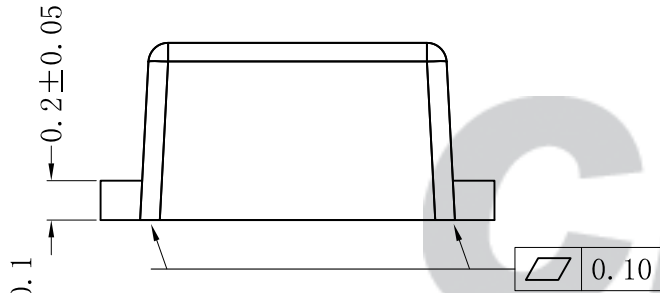

SUGGESTED PCB LAYOUT  
(COMPONENT SIDE)

专利产品

Tolerance X.X ±0.30 X.XX ±0.20 X.XXX ±0.10 Angle ±3.0°	<b>CNJST 捷仕泰企业</b>		Drawn: 李浩然 2023.01.05
	Model No.: MD-201009-H1MA-R		Checked: 吴丹平
UNIT: mm	Model Name: Stopper		Approved: 林旭芝
		SCALE: FULL	REVISION: C/0
			DWG NO.: CNJST/GCCP-0457

REV.	DATE	DESCRIPTION	APPD.	NO.	DESCRIPTION	QTY	MATERIAL	PLATING/COLOR
C/0	2023.01.05	更新模板	李浩然	②	Contacts	2	Phosphor Bronze	Tin-plated
B/0	2017.11.16	NEW RELEASE		①	Insulator	1	PA9T (UL94 HB)	Nature