

RoHS Compliant

ORDER INFORMATION:

MD-282010-H1MA-R

PART No.	MD-282010-H1MA-R	PACKAGING:	R=REEL
No. OF CIRCUITS:		PLATING:	A=Tin-plated
Length		PLASTIC MATERIAL:	H1M=PA9T (Nature)
Width			
Height			

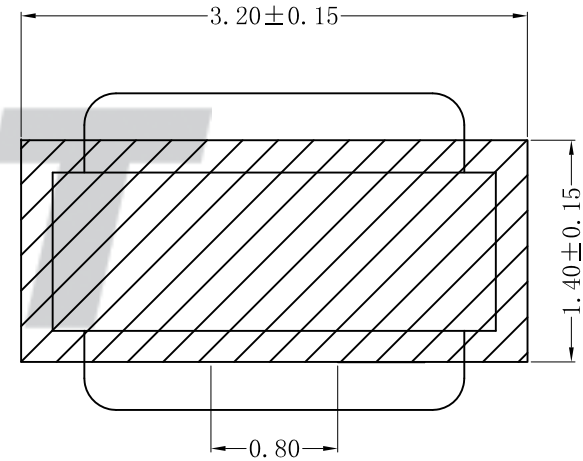
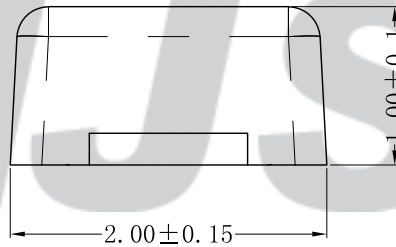
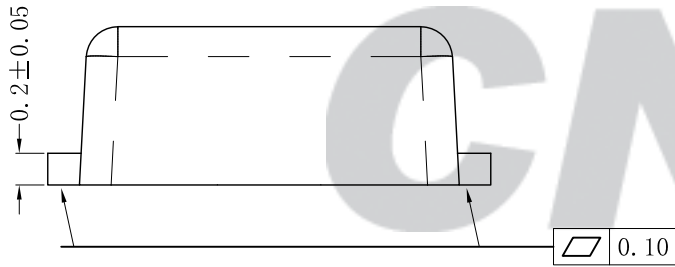
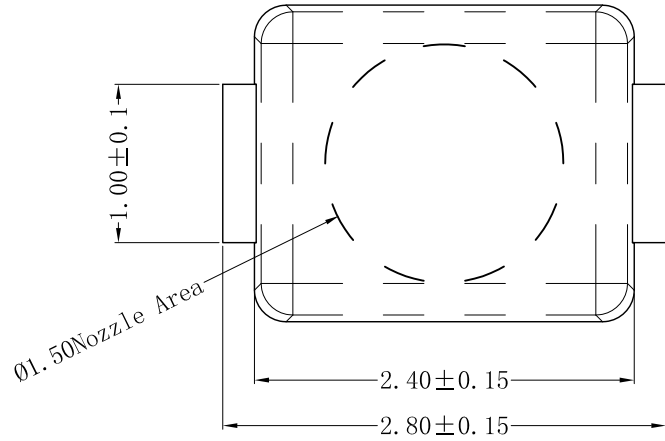

SUGGESTED PCB LAYOUT
(COMPONENT SIDE)

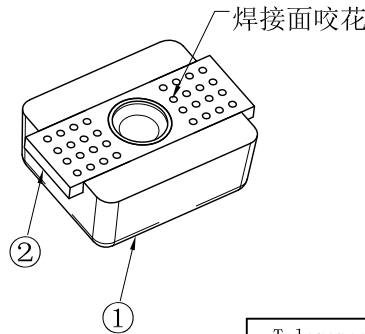
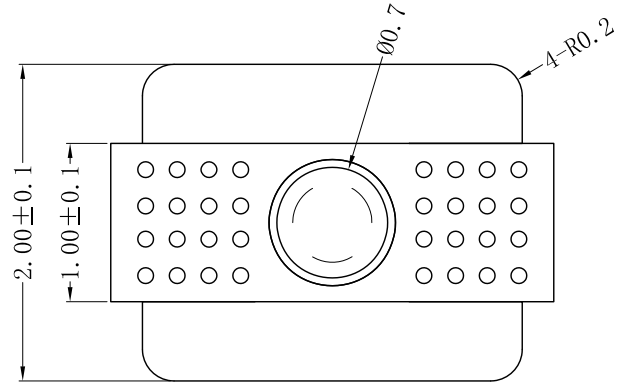

专利产品

Tolerance X.X ±0.30 X.XX ±0.20 X.XXX ±0.10 Angle ±3.0°	CNJST 捷仕泰企业		Drawn: 李浩然 2023.01.05
	Model No.: MD-282010-H1MA-R		Checked: 吴丹平
UNIT: mm	Model Name: Stopper		Approved: 林旭芝
		SCALE: FULL	REVISION: C/0
			DWG NO.: CNJST/GCCP-0506

REV.	DATE	DESCRIPTION	APPD.	NO.	DESCRIPTION	QTY	MATERIAL	PLATING/COLOR
C/0	2023.01.05	更新模板	李浩然	②	Contacts	2	Phosphor Bronze	Tin-plated
B/0	2017.11.16	NEW RELEASE		①	Insulator	1	PA9T (UL94 HB)	Nature