

RoHS Compliant

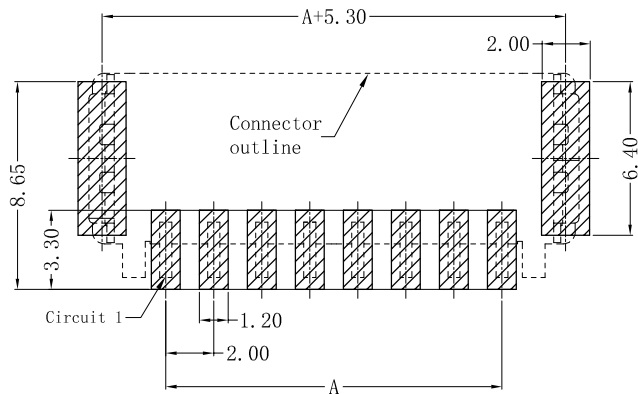

SUGGESTED PCB LAYOUT
 (COMPONENT SIDE)
 General Tolerance ± 0.05

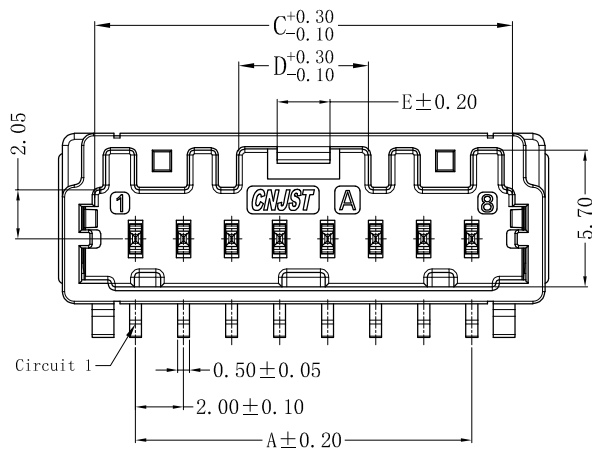
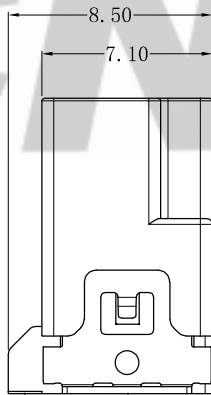
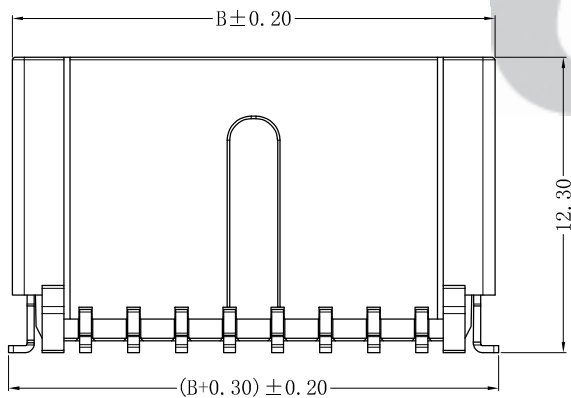

0.10

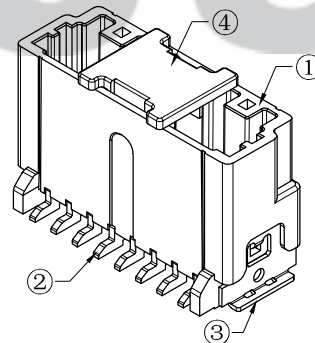

SPECIFICATION

- 1 Contact resistance: $\leq 30m\Omega$
- 2 Insulation resistance: $\geq 100M\Omega$
- 3 Rated voltage: 50 V AC DC
- 4 Rated current: 5.0 A AC DC
- 5 Withstand Voltage: 1000V AC/minute
- 6 Temperature Range: $-40^{\circ}C \sim +125^{\circ}C$

ORDER INFORMATION:

QA2008AWV-**-D1MB-R-X-A

PART No.	VERSIONS: A
No. OF CIRCUITS: 02~10	X=Cap
PLASTIC MATERIAL: D1M=PA9T (Nature)	PACKAGING: R=Reel
	PLATING: B=Matte Sn

Circuits	Dimensions (mm)				
	A	B	C	D	E
02	2.00	8.10	5.40	5.00	1.80
03	4.00	10.10	7.40	7.00	1.80
04	6.00	12.10	9.40	5.00	1.80
05	8.00	14.10	11.40	5.40	2.20
06	10.00	16.10	13.40	5.40	2.20
07	12.00	18.10	15.40	5.40	2.20
08	14.00	20.10	17.40	5.40	2.20
09	16.00	22.10	19.40	5.40	2.20
10	18.00	24.10	21.40	5.40	2.20

注：建议客户优先选择我司公母端产品配套使用，若在没有使用我司公母端配套产品情况下，出现因产品不匹配的质量问题，我司将不承担任何风险及责任。

REV.	DATE	DESCRIPTION	APPD.	NO.	DESCRIPTION	QTY	MATERIAL	PLATING/COLOR	UNIT: mm	Model No. : QA2008AWV-**-D1MB-R-A	Model Name: 2.00mm PITCH 180° WAFER-SMT TYPE	DWG NO. CNJST/GCCP-0837
				④	Cap	1	LCP (UL94V-0)	Nature	X.X ± 0.30		SCALE: FULL REVISION: C/0	Drawn: 黄美程 2023.07.06
				③	Solder Tab	2	Brass	Matte Sn	X.XX ± 0.20			Checked: 吴丹平
				②	Contacts	2~10	Brass	Matte Sn	X.XXX ± 0.10			Approved: 林旭芝
C/0	2023.07.06	NEW RELEASE	黄美程	①	Insulator	1	PA9T (UL94V-0)	Nature	Angle $\pm 3.0^{\circ}$			

CNJST 捷仕泰企业

Drawn: 黄美程 2023.07.06

Checked: 吴丹平

Approved: 林旭芝

DWG NO. CNJST/GCCP-0837

RoHS Compliant

PIN位结构示意图

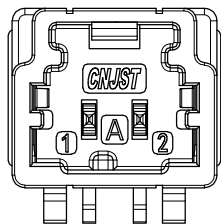

2P

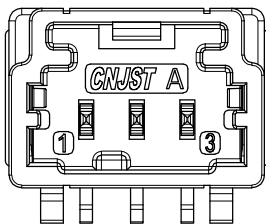

3P

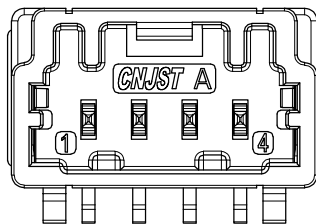

4P

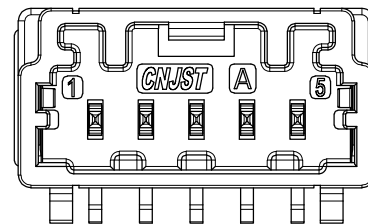

5P

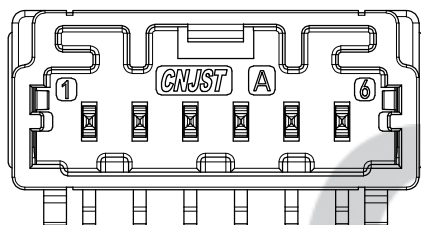

6P

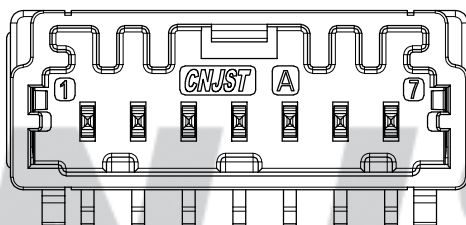

7P

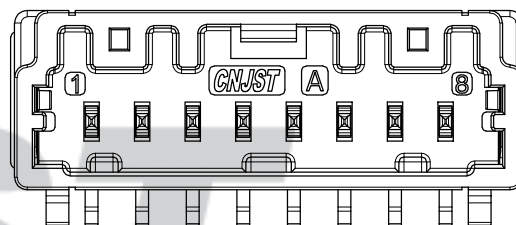

8P

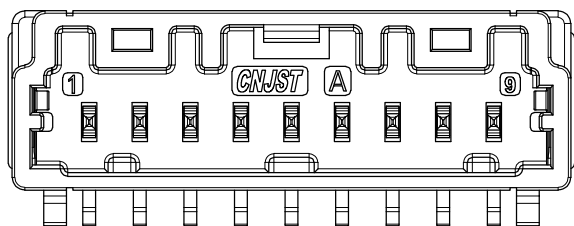

9P

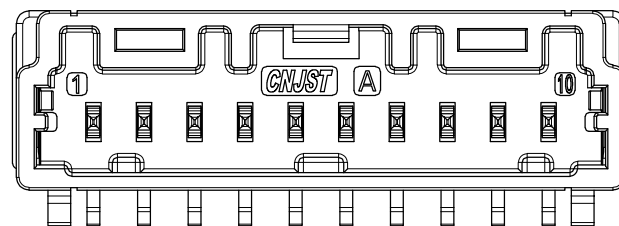

10P

注：建议客户优先选择我司公母端产品配套使用，若在没有使用我司公母端配套产品情况下，出现因产品不匹配的质量问题，我司将不承担任何风险及责任。

Tolerance X.X ±0.30 X.XX ±0.20 X.XXX ±0.10 Angle ±3.0°	CNJST 捷仕泰企业		Drawn: 黄美程 2023.07.06
	Model No.: QA2008AWV-**-D1MB-R-A		Checked: 吴丹平
UNIT: mm	Model Name: 2.00mm PITCH 180° WAFER-SMT TYPE	Approved: 林旭芝	
		SCALE: FULL	REVISION: C/0
		DWG NO. CNJST/GCCP-0837	

C/0	2023.07.06	NEW RELEASE	黄美程
REV.	DATE	DESCRIPTION	APPD.